

A4

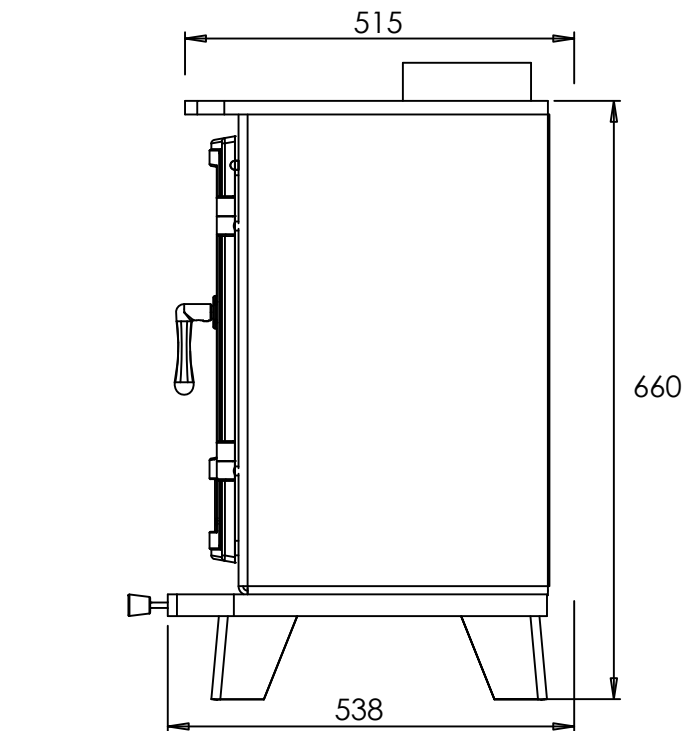
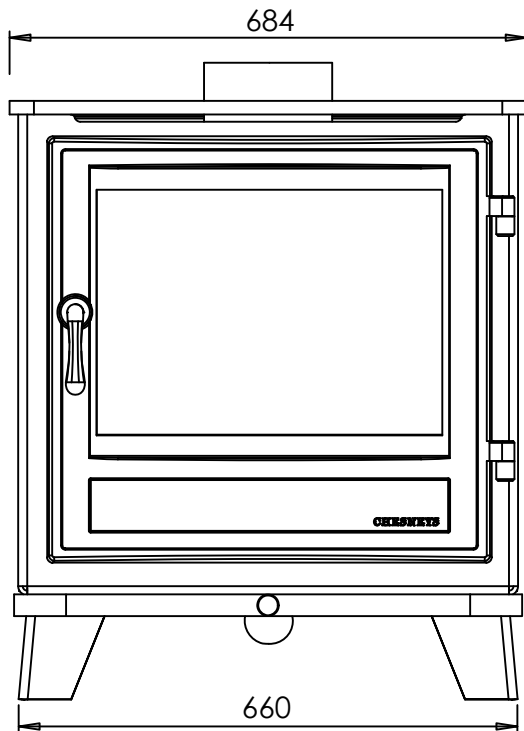
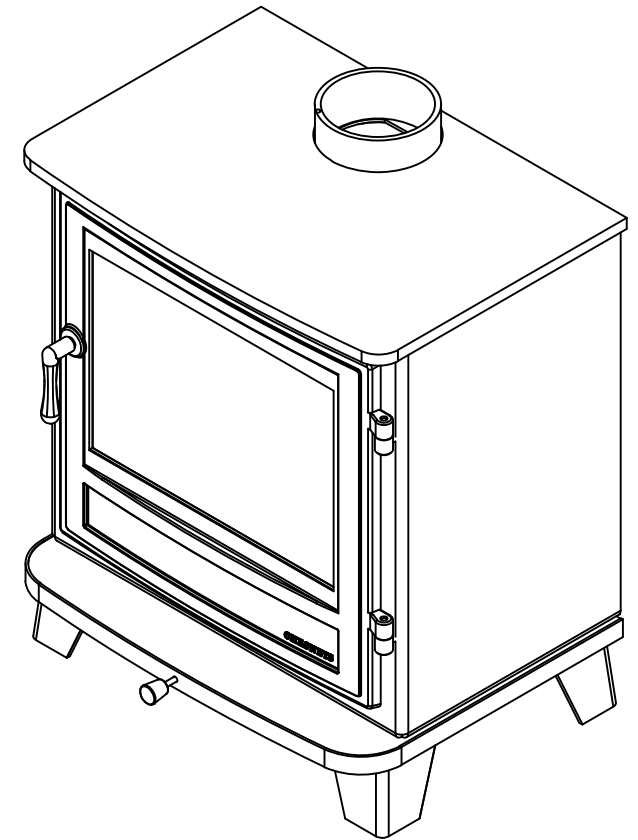
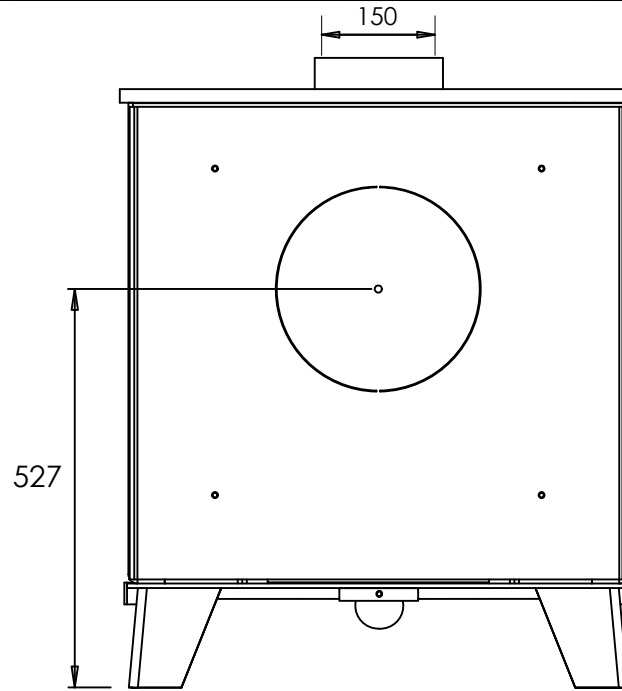
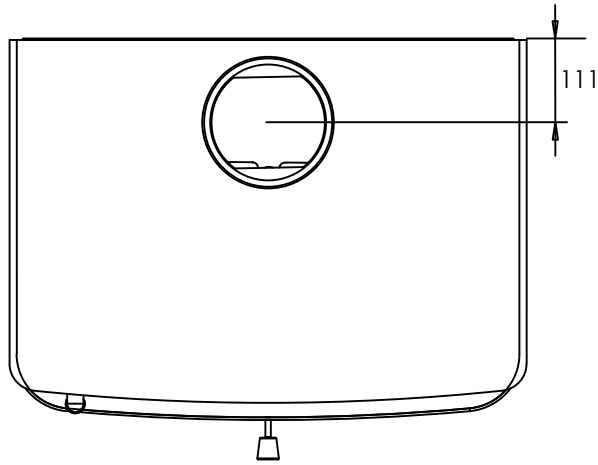

PLEASE NOTE
CLEARANCE TO COMBUSTIBLES:
REAR 500mm SIDES 400mm

CHESNEYS

SALISBURY 12WS

HEAT RANGE: 5.5kW-11.5kW	NOM. HEAT OUTPUT: 10.6kW
NET EFFICIENCY: 75.9%	FLUE OUTLET: 150MM
WEIGHT: 137KG	SCALE: 1:10 @A4

MINIMUM RECOMMENDED FLUE HEIGHT 3m WITH FLUE DRAUGHT OF 12 PASCALS INSIDE THE FLUE OR 9 PASCALS AT THE TEST POINT AT THE TOP OF THE FLUE.